

STORAGE UNIT

MODULE COMFORT PRO 1.4

ТУМБА ДЛЯ ХРАНЕНИЯ

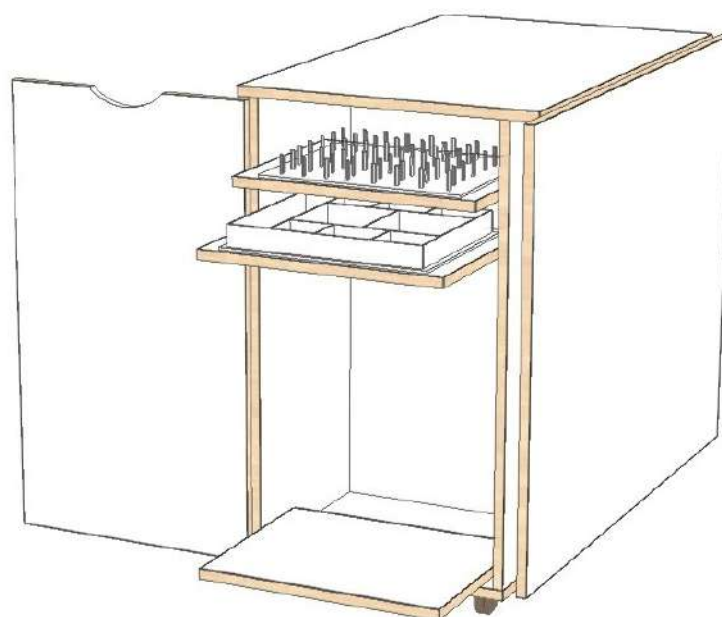

SYMBOLS



ATTENTION

ВНИМАНИЕ



ASSEMBLY & ADJUSTMENT

СБОРКА РЕГУЛИРОВКА



OPERATION

ЭКСПЛУАТАЦИЯ



STORAGE

ХРАНЕНИЕ

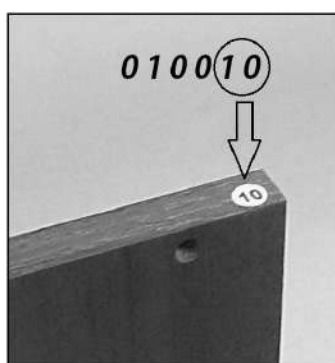

INDICATING MARK

ОБОЗНАЧЕНИЕ



SPECIAL OPERATION

СПЕЦИАЛЬНЫЕ ОПЕРАЦИИ

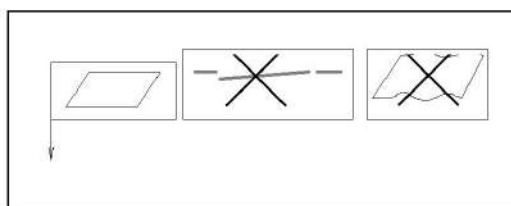

EVEN SURFACE



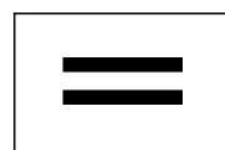











РОВНАЯ ПОВЕРХНОСТЬ









EQUALITY

РАВЕНСТВО

010001	1 x	010002	1 x	010004	1 x
010006	1 x	010007	1 x	010011	4x
010013	5x	010026	1 x	010028	3 x
010030	1 x	010037	4x	010040	1 x
010041	1 x				

5x 020013 CR  L300		5x 020013 CL  L300		2x 020018 	2x 020040 	2x 020041 
4x 020051 C  L350			4x 020051 D  L350			
L350 1x 020052 R 			1x 020052 L  L350			
 4x 020054 R H 85 L300		 4x 020054 L H 85 L300		 4x 020053		
 1x 020055 R H 150 L300		 1x 020055 L H 150 L300				

030002 68x  3,5 * 16	030003 10x  6,2 * 50	030033 48x  4,2 * 13	8x 030028  3,5 * 30
030011 10x  φ 15	030012 4x  φ 18	4x 030013  L 35	030014 4x  φ 15 h 12
030015 4x  φ 8 * 30	030022 4x  M 10	030023 4x  φ 10	030031 4x  φ 10 s2,5

S4 **1x**

1x 050004



1x 050005



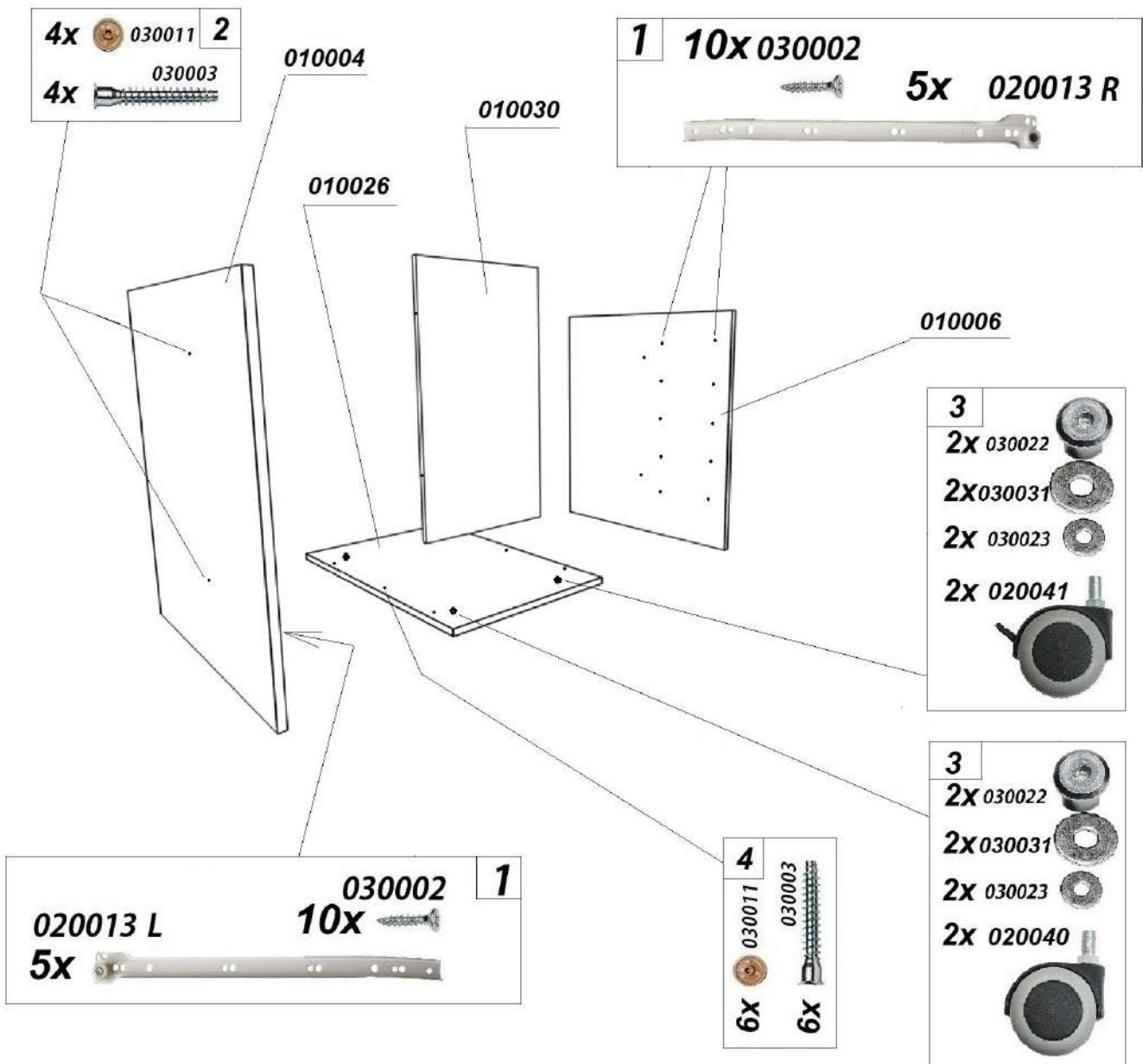
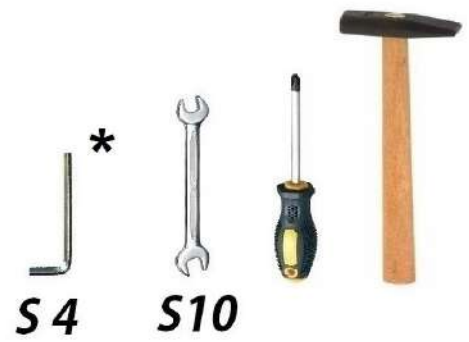

* Входит в комплект стола.
 Included into table set.

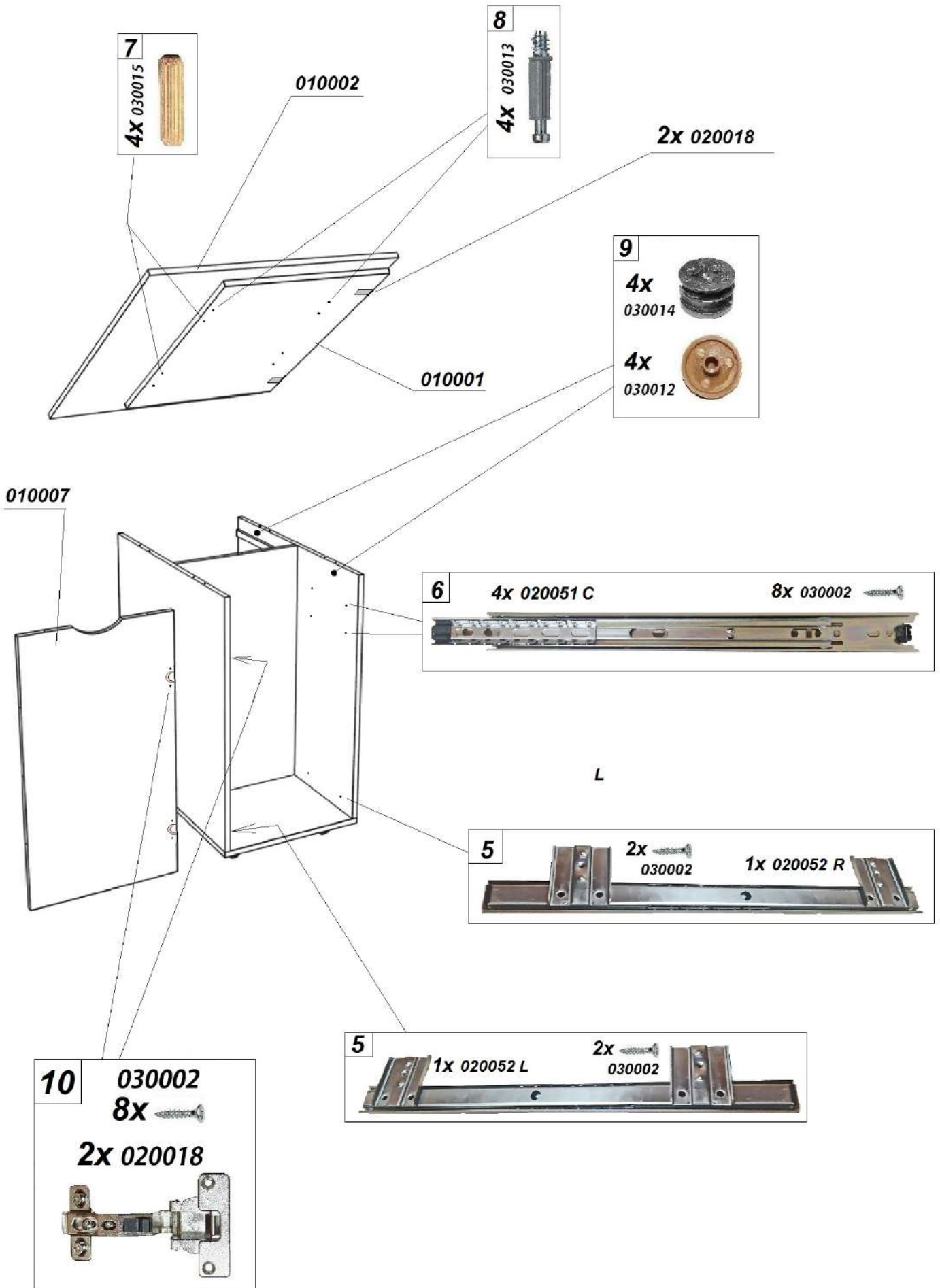

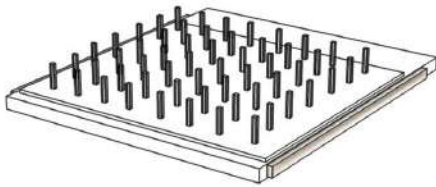

11

030002
4x 

1x 050004

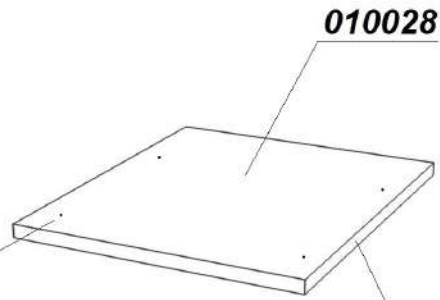

12

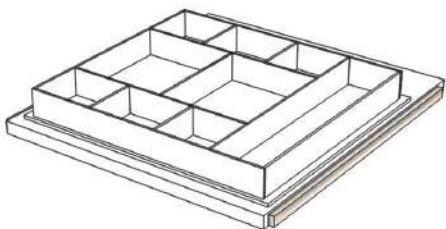

2x 020051 D **4x 030028** 



13

030002
4x 

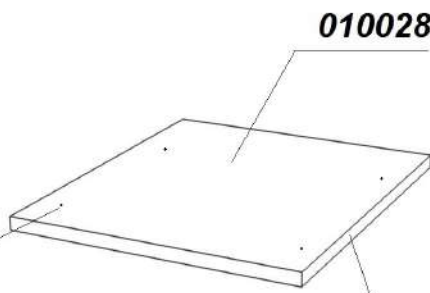
1x 050005



14

2x 020051 D **4x 030028** 

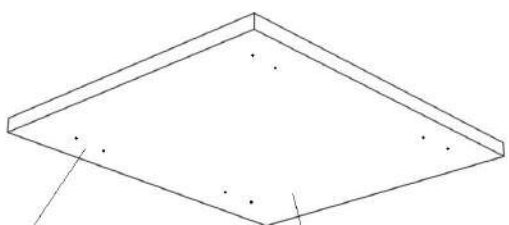
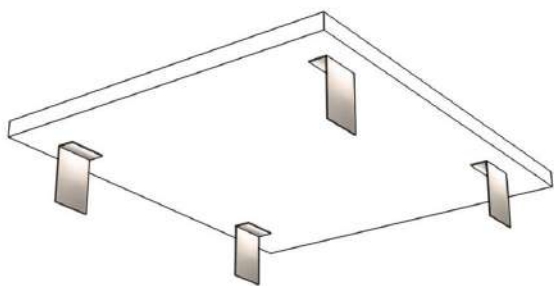

15

4x
020053

8x 

030033



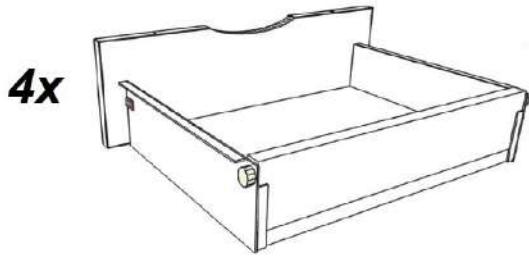

010037

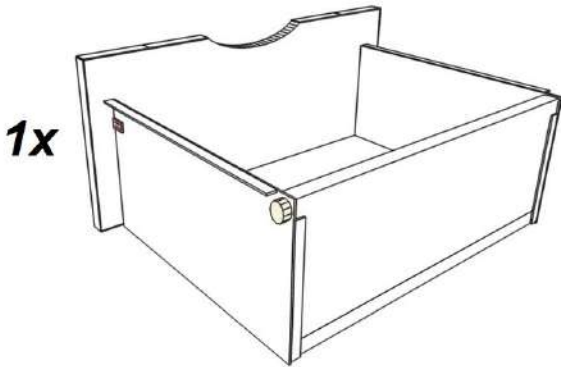
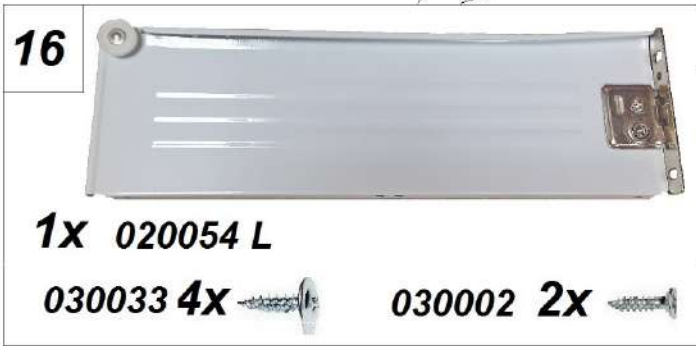
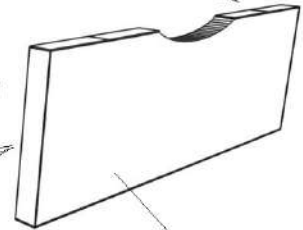
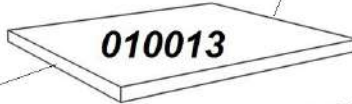
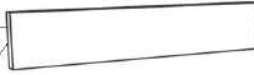

010040

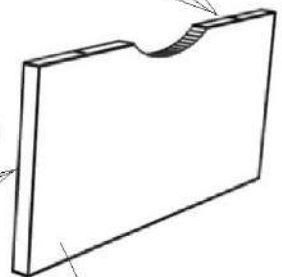
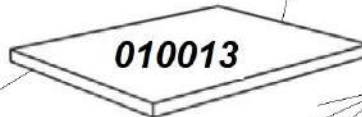
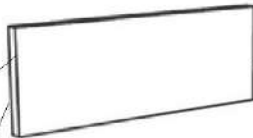

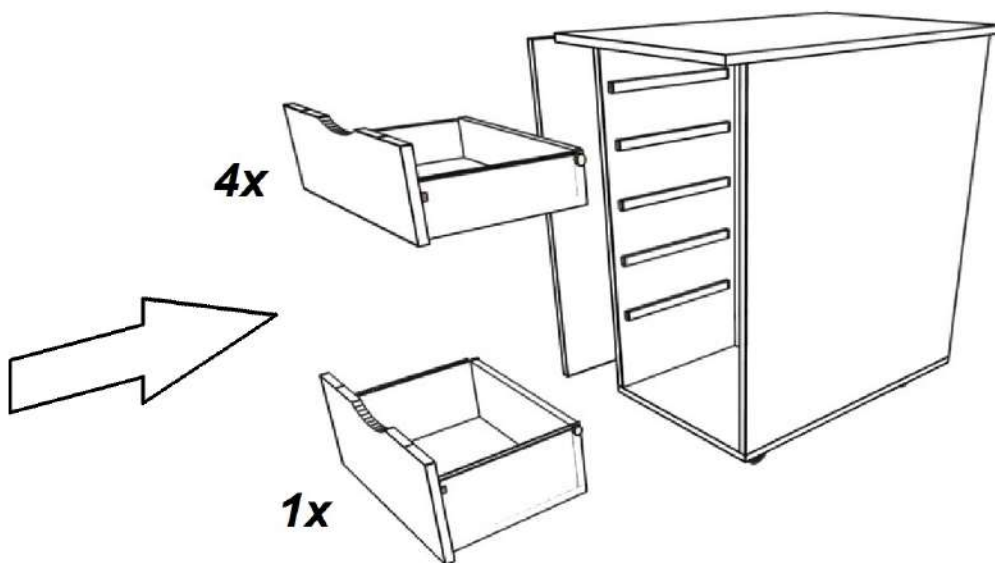
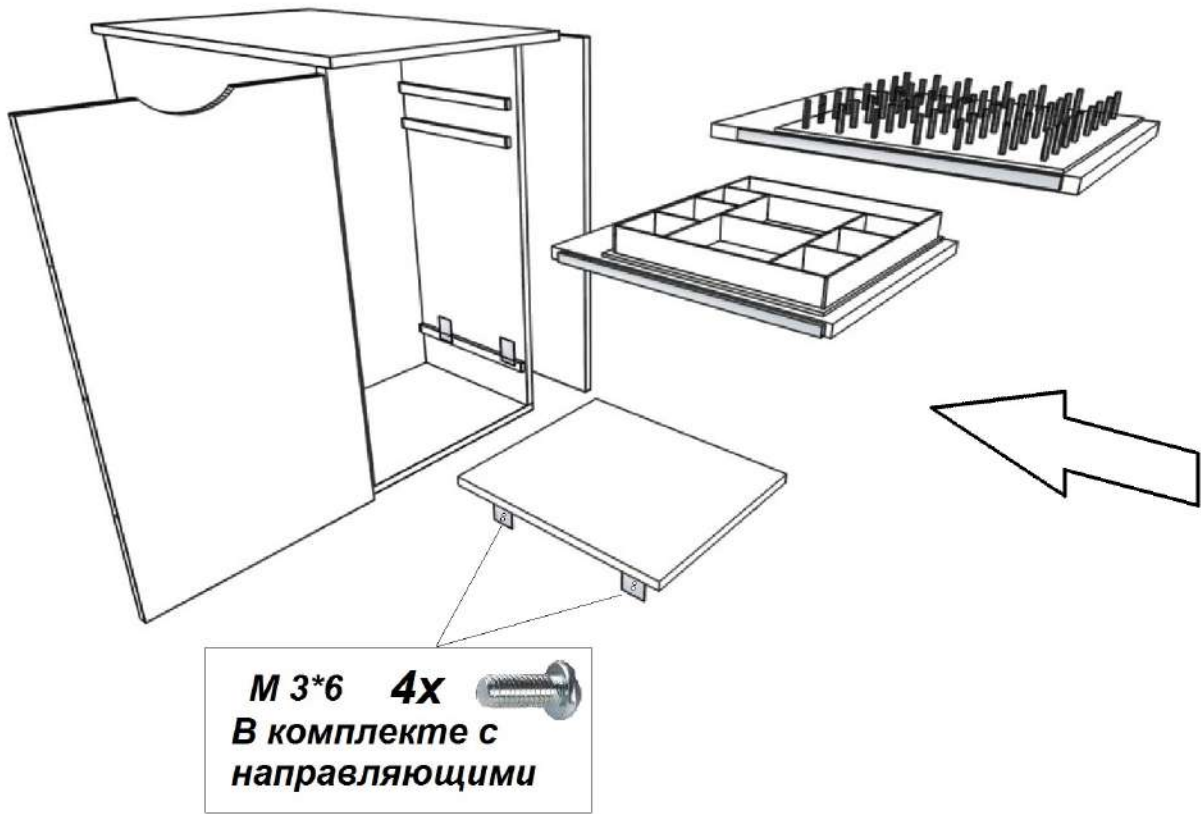

SEWING MACHINE TABLE
MODULE COMFORT PRO 1.1
MODULE COMFORT PRO 1.1 L (XL)
СТОЛ ДЛЯ ШВЕЙНОЙ МАШИНЫ



SEWING MACHINE TABLE
MODULE COMFORT PRO 1.2
СТОЛ ДЛЯ ШВЕЙНОЙ МАШИНЫ



STORAGE UNIT
MODULE COMFORT PRO 1.3
ТУМБА ДЛЯ ХРАНЕНИЯ



STORAGE UNIT
MODULE COMFORT PRO 1.4
ТУМБА ДЛЯ ХРАНЕНИЯ



МОДУЛЬНАЯ ПЛАТФОРМА
COMFORT PRO 1 (3 ЭЛЕМЕНТА)



МОДУЛЬНАЯ ПЛАТФОРМА
COMFORT PRO 1 (4 ЭЛЕМЕНТА)

